

# MAURER Earthquake Protection Systems

As unique as the buildings they protect

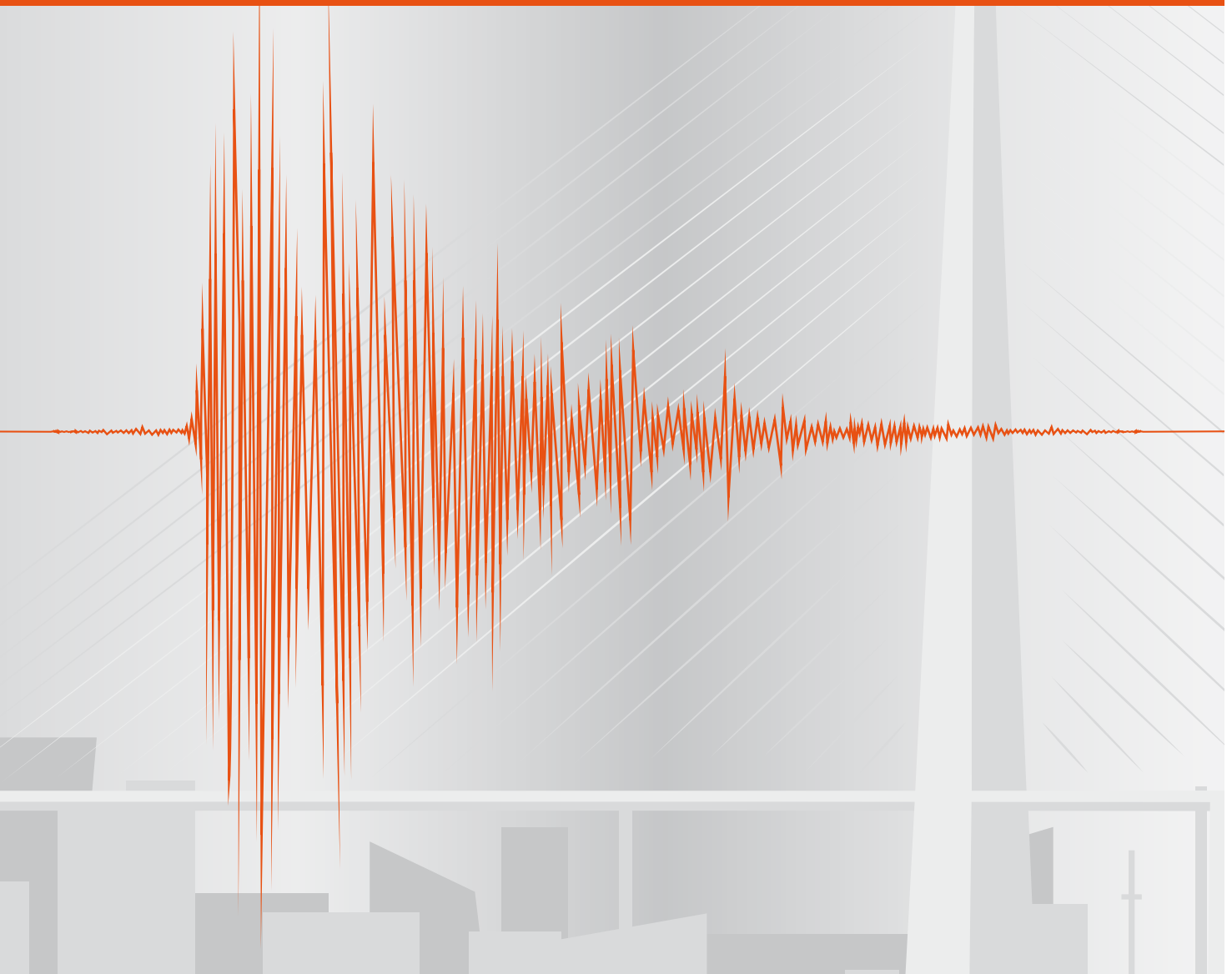

## >> MAURER Earthquake Protection Systems Content

<b>Structural Protection Systems</b>	<b>P. 04</b>
<b>Structural Analysis</b>	<b>P. 05</b>
<b>Basic Concepts of Earthquake Protection</b>	<b>P. 06</b>
<b>Hydraulic Coupling and Damping Elements</b>	<b>P. 08</b>
>> Permanent Restraints (HK; HKE)	P. 08
>> Shock Transmission Unit (MSTU)	P. 08
>> Shock Transmitter with Load Limiter (MSTL)	P. 08
<b>Bearing Elements for Base Isolation</b>	<b>P. 10</b>
>> Elastomeric Isolators	P. 10
>> Sliding Isolators	P. 12
>> Hydraulic Dampers (MHD)	P. 14
<b>Steel Hysteretic Dampers</b>	<b>P. 16</b>
<b>Structural Expansion Joints</b>	<b>P. 18</b>
>> Earthquake Expansion Joints for Road Bridges	P. 18
>> Swivel-Joist Expansion Joints of Type DS	P. 20
>> Fuse Box for Modular Joints	P. 21
<b>Project-Specific Testing</b>	<b>P. 22</b>
<b>References</b>	<b>P. 25</b>



# MAURER Structural Protection Systems – as unique as the buildings they protect

>> “Earthquakes are natural disasters whose feature is that most of the human and economic losses are not due to the earthquake mechanisms, but to failures in man-made facilities, like buildings, bridges etc., which supposedly were designed and constructed for the comfort of the human beings.” (Bertero)

The above observation brings a note of optimism and is encouraging because it tells us that, in the long run, seismic problems are solvable in principle. The task of solving these problems is attributed to Seismic Engineering. The advances in this field have already played a significant role in reducing seismic hazards through the improvement of the built environment, finally making possible the design and construction of earthquake-resistant structures. Progress has

mainly been the result of newly developed design strategies e.g. Base Isolation, which could not have found useful application without the parallel development of the “seismic hardware” needed for their implementation.

Thus, several research laboratories and industrial concerns have invented and perfected a series of devices that exploit well known physical phenomena which have been adapted to the protection of structures.

MAURER has distinguished itself in this very real race, when in the middle of the 1990s we decided to invest both human and financial resources, that have significant led to its present position of worldwide leadership.

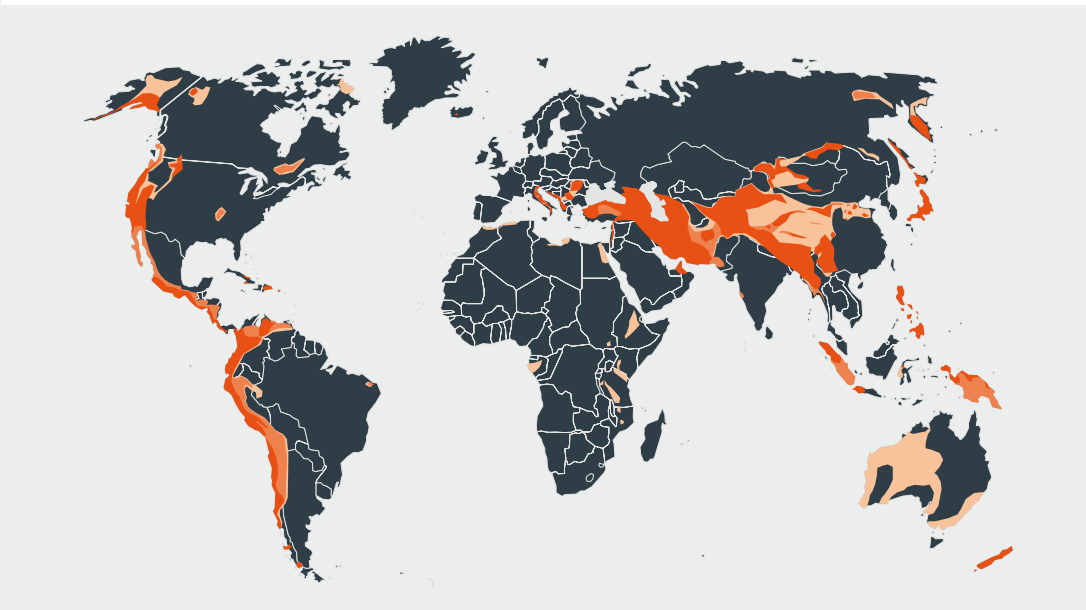

>> The purpose of this brochure is:

A) to illustrate the manner in which MAURER has faced and solved the problems deriving from the practical application of the new design strategies.

B) to present the devices that have been developed and perfected towards this goal.

World map of the most-affected earthquake zones

MAURER has adopted the strategy of sizing its devices on a case-by-case basis, i.e. the “tailor-made” philosophy, with evident advantages for the customer.

Acropolis Museum,  
Athens



## MAURER is more than a supplier of Seismic Hardware



MAURER has acquired a vast experience in the application of modern seismic protection technologies within a wide variety of structures to minimise earthquake induced damage.

MAURER's experts offer structural designers and architects assistance in the definition of the protection systems and in the selection of devices best suited for each case, considering not only the seismicity of the site, but also the structural, functional and architectural needs of the works.

Isolated building, ONASSIS Home of Letters and Fine Arts, Athens. Earthquake protection with isolators in the basement

The quality and efficiency of the proposed protection systems are validated via the most up - to - date methods of computer modelling.

### >> Better adaptation thanks to a wider range of Seismic Hardware

The more types of seismic devices a designer has to choose from, the better he can adapt his solution. MAURER offers the world's most extensive range of seismic devices. Our specialists always develop the best earthquake protection system for your requirements.

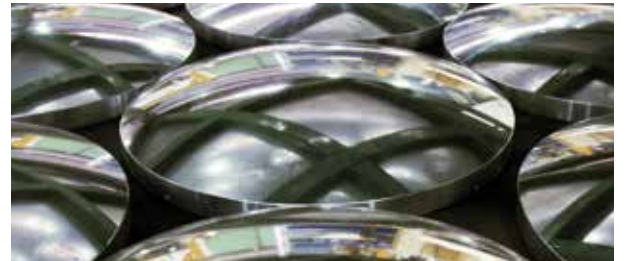



# Seismic Analysis – a tool to develop through our devices your Seismic Protection System

The linear (or modal) analysis represents the most commonly applied method to evaluate the effects (forces, deformations etc.) of an earthquake. The seismic input in this case is the "elastic response spectrum". However, we can resort to this procedure only if a set of conditions are met. The most important of them being the effective damping ratio must be less than 30%. One of the major drawbacks of the linear analysis is the inability to verify whether or not the isolation system possesses an adequate Re-Centring capability.

With the non-linear (time history) analysis, we can better validate and optimize the structural protection system, taking into account all local conditions. The seismic input in this case consists of a set of ground motion time - histories (accelerograms). To conduct the non - linear analyses the following data is required:

## >> Structural data

Structural drawings, cross sections (deck, abutment, pier), moment of inertia, torsion constant, shear stiffness, materials (modulus of elasticity, shear modulus, density, etc.), foundation (dimensions, Winkler - modulus, etc).

## >> Earthquake data

Response spectrum and/or representative accelerograms, loads under seismic conditions, allowable bending moments, shear and axial forces, displacements and any further specific requirements of the designer.

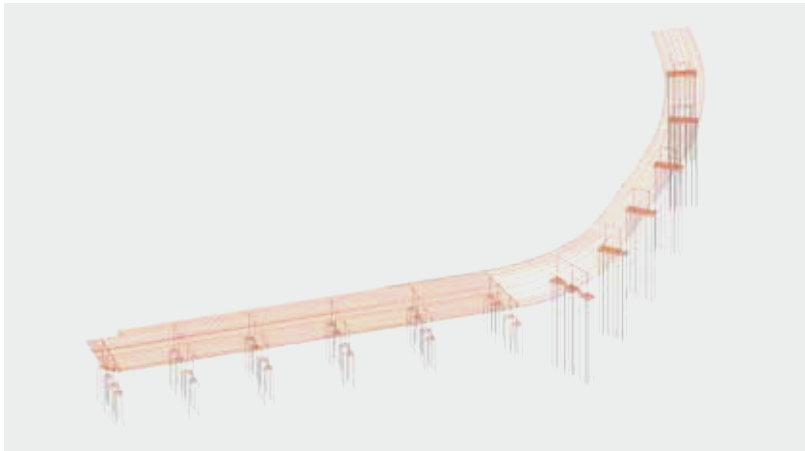

Axonometric view of a rail-way bridge, 3D mathematical model

## >> The advantages of the MAURER Non-linear Structural Analysis

- Accurate determination of structural displacements including torsional effects.
- Accurate calculation of response forces that affect the elements and the structure as a whole.
- Optimization of seismic protection system in terms of efficiency and economy.
- Evaluation of considerable structural cost savings based on less reinforcement and savings in terms of steel and concrete.
- Precise evaluation of actual safety margins within the structure and the seismic devices.
- Validation of designer's analysis through the comparison with MAURER's results.
- Precise evaluation of the isolation system's Re-Centring capability.

## Structural protection through two basic concepts of earthquake protection

Having once established the level of protection required, the seismic engineer must make certain strategic choices and depending on the type of structure, the seismicity and geological nature of the site, the norms currently in force, etc. . Today, seismic engineers can rely upon numerous solutions and relevant types of seismic devices that have already been successfully adopted with success within the last three decades. These solutions can be grouped into two main types:

>> 1. Provide the structural members with sufficient flexibility, strength and ductility to absorb and partially dissipate the energy through the intrinsic viscous mechanism; these solutions are referred to as “**strengthening**” or “**conventional design**” approaches.

>> 2. Aim at protecting the structure against earthquake damage by limiting the seismic effects (rather than resisting them) through the use of devices properly inserted into the structure; this approach is usually referred to as “**seismic mitigation**”.

>> Here below the flowchart places into perspective the design choices and the different types of anti - seismic devices that allow their practical application.

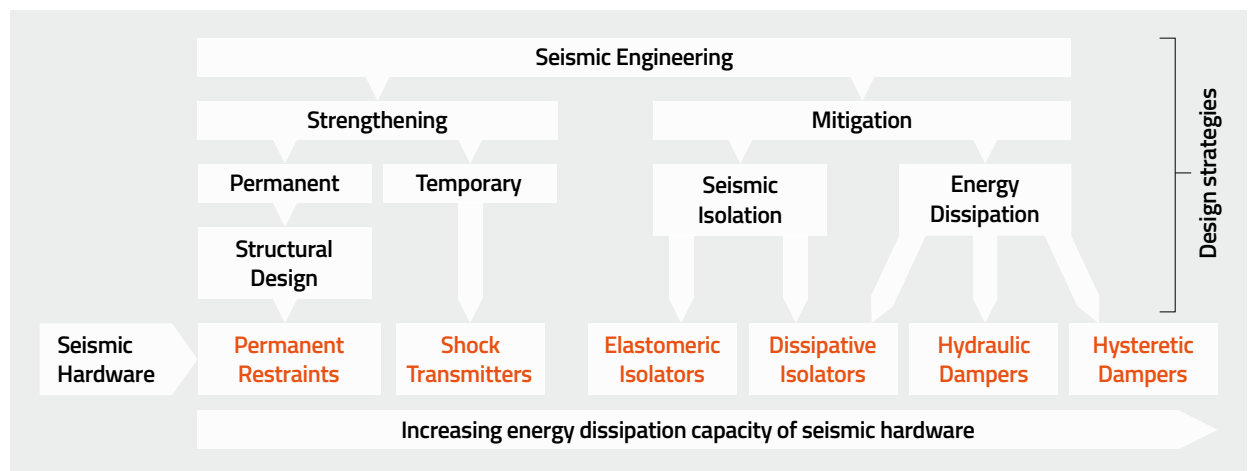

### >> Strengthening

The design engineer who has selected the adoption of traditional techniques, essentially consisting in strengthening the structure – has before him two possible alternatives:

>> 1. Fit the structure with permanent restraints only, proportioning its structural members with adequate flexibility, resistance and ductility.

>> 2. Insert at appropriate locations of the structure temporary restraint devices, which allow slow thermal movements and lock-up for impact when an earthquake occurs.

The superior seismic behavior of hyperstatic structures, and bridges in particular, is well known. The simple explanation for this fact is that in hyperstatic structures, all structural members are forced to work together at a critical moment. However, especially in the case of bridges, construction techniques e.g. prefabricated beams and the risk of occurrence of differential settling on the foundations often suggest the choice of isostatic arrangements. The advantages of the two concepts can be maintained through the adoption of Hydraulic shock transmitters.

## >> Mitigation

In the bar chart the alternative to structural reinforcement is Seismic Mitigation, which is the most effective design approach for protecting structures erected in earthquake prone zones. The latter can be obtained through:

- Seismic Isolation,
- Energy Dissipation, or, better of a
- combination of both.

Seismic isolation is by far the most used design approach to reduce the seismic response following an earthquake impact, that is to say, to mitigate its disastrous effects. A proper isolation system must be capable of appropriately ensuring the following four main functions occur:

- Transmission of vertical loads
- Lateral flexibility
- Re-Centring capability
- Energy dissipation

Some specialists also list a fifth fundamental function, namely:

- Stiffness under service loads

Some types of isolators intrinsically possess this function. For others, we must resort to the so-called "Fuse Restraints". MAURER has developed several types of both mechanical and hydraulic.

Comparison between acceleration in a conventional and an isolated structure

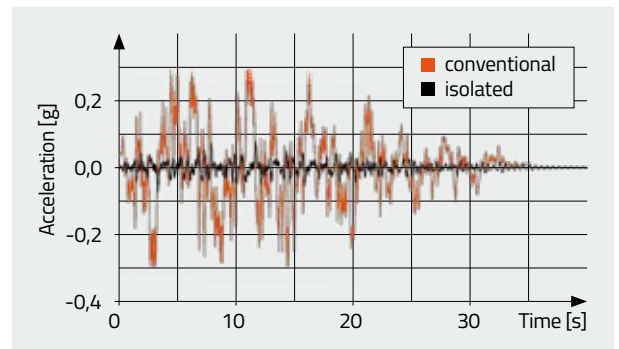
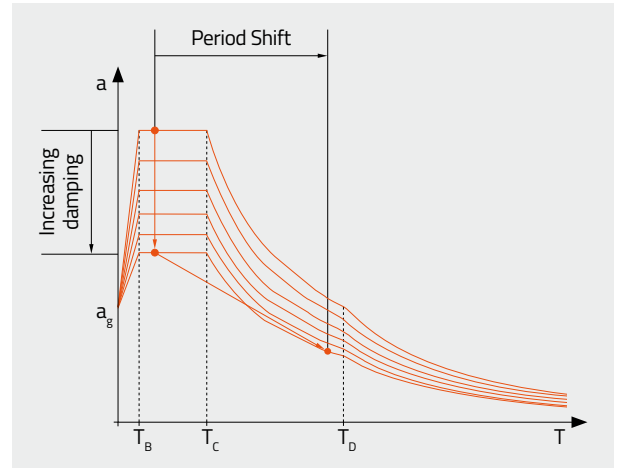

If the adoption of Seismic Isolation is not feasible and the structure possesses sufficient flexibility i.e. important relative displacements occur during an earthquake due to elastic deformation of its structural elements then Energy Dissipation (damping) can be effectively used to attain Seismic Mitigation. This is achieved through the adoption of Hysteretic Dampers

or Hydraulic Dampers, which are inserted into the structure at appropriate locations. Skilled MAURER engineers are available to assist designers in choosing the most appropriate Seismic Hardware on a case-by-case basis, as well as optimizing the adopted solution in terms of costs, performance, reliability, durability etc..



Djamaâ El Djazir Mosque, Algiers

## MAURER Restraint Systems for Strengthening

Russkiy Island Bridge, laterally fixed and longitudinally movable permanent restraint - HKE for  $F_v$  of 20 MN and temporary during construction for  $F_x$  of 25 MN

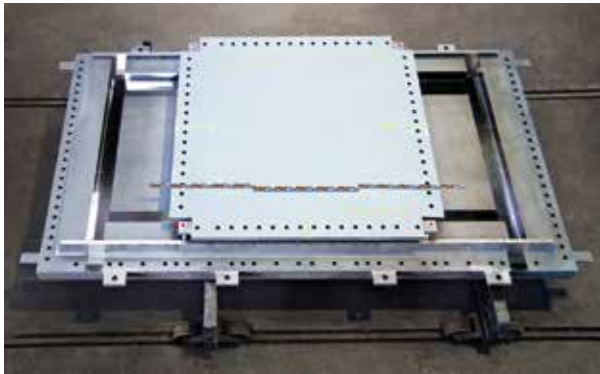

### >> Permanent Restraints (HK; HKE)

Even if permanent restraints represent the family of the conceptually simplest seismic hardware, nonetheless they comprise a large variety of devices. Thus their standardization is problematic and MAURER has adopted the strategy of the "tailor-made" design according to the specifications given by the designers. These restraints can be designed to laterally fix the structure in X and Y direction (HK device) or guide it in one direction (unidirectional = HKE device) only.

### >> Shock Transmission Unit (MSTU)

Shock Transmitters are devices that allow slow movements (<0.1 mm/s) without appreciable resistance (1–4% of  $F_{max}$ ), but prevent those of sudden onset without appreciable deformations (0.5–3% of stroke capacity in loaded direction).

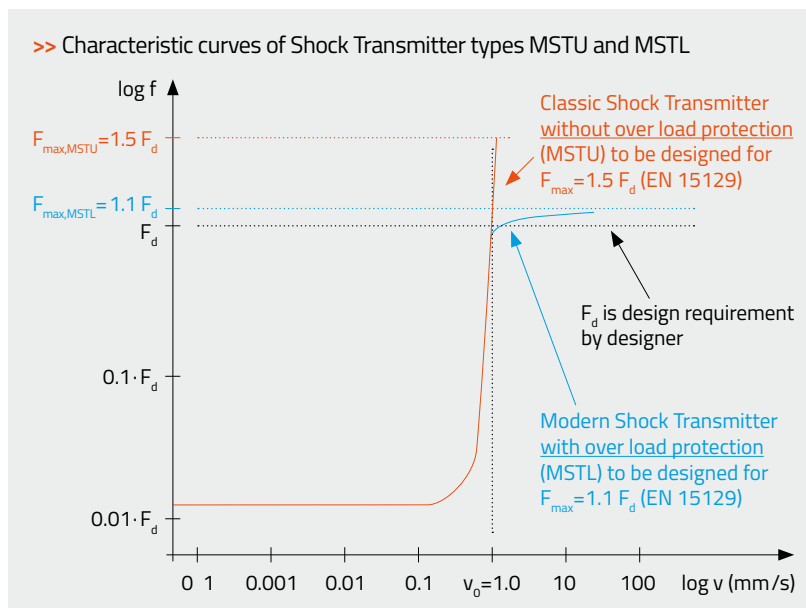

In the shock transmitter developed by MAURER, denominated MSTU, both resistance to the movements due to thermal variations and deformations consequent to an earthquake attack have been minimized, thanks to the adoption of function, special materials, accurate design procedures and proprietary fabrication processes. The MSTU activation or lock-up velocity  $v_0$  is usually individually adapted in the range from 0.1 to 1.5 mm/s, but for very large structures can reach the value of 5 mm/s.

### >> Shock Transmitter with Load Limiter (MSTL)

The European Norm EN 15129 requires that the reliability factor of shock transmitters on their design force  $F_d$  shall be  $\gamma_x = 1.5$ , unless an overload protection system or "load limiter" is incorporated. In this case, the value of the reliability factor can be reduced to  $\gamma_x = 1.1$  and shall be applied to the design system force  $F_0$  specified by the designer. The adoption of MSTLs decreases the forces acting on the structural members by 26%. It increases the overall safety of the devices and the structure as it is granted that all devices in serial and parallel arrangement

are equally and simultaneously loaded when affected by sudden service or seismic impacts, this is not the case with classic STUs. These might be overloaded even with more than the reliability factor of 1.5 applied onto the design force  $F_d$ . Therefore the MSTL application reduces the costs of the structural members and even the cost of the shock transmitter itself, because an MSTL is more compact, i.e. smaller than an MSTU. The MSTL is always the most economical solution, while providing additional technical benefits and reliability.



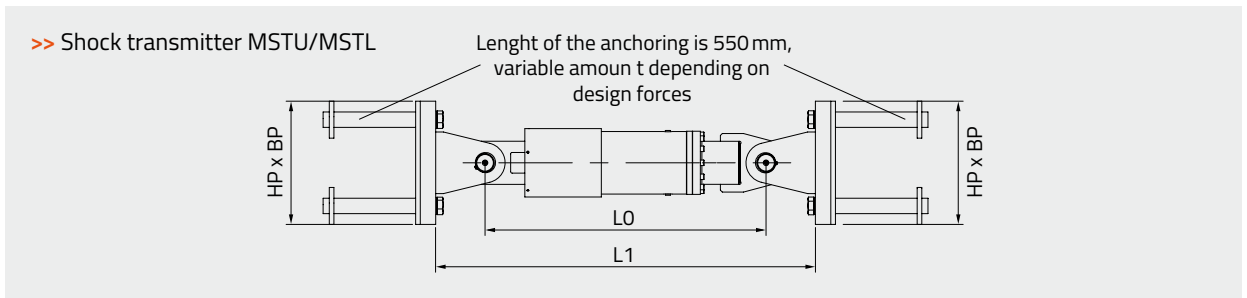

$F_d$ [kN]	displ. [±mm]	MSTU				MSTL			
		L1 [mm]	LO [mm]	HP [mm]	BP [mm]	L1 [mm]	LO [mm]	HP [mm]	BP [mm]
500	200	2,000	1,700	450	380	1,930	1,650	400	350
1,000	200	2,220	1,880	500	410	2,120	1,800	450	380
1,500	200	2,460	2,060	550	450	2,340	1,960	500	410
2,000	200	2,680	2,260	600	490	2,510	2,110	550	450
2,500	200	2,890	2,430	650	550	2,700	2,260	600	490
3,000	200	3,070	2,590	700	600	2,850	2,390	650	550
3,500	200	3,280	2,760	800	660	3,020	2,520	700	600
4,000	200	3,480	2,920	850	700	3,190	2,650	750	630
4,500	200	3,700	3,100	900	750	3,370	2,790	800	660
5,000	200	3,900	3,280	950	800	3,540	2,940	850	700
5,500	200	4,110	3,450	1,050	860	3,720	3,080	900	750
6,000	200	4,310	3,630	1,100	900	3,890	3,230	950	800
6,500	200	4,620	3,800	1,150	950	4,180	3,380	1,000	830
7,000	200	4,700	3,980	1,250	1,000	4,240	3,540	1,050	860
7,500	200	4,900	4,160	1,300	1,050	4,420	3,700	1,100	900
8,000	200	5,130	4,350	1,350	1,100	4,620	3,860	1,150	950

$F_d$  = Design value provided by designer for ULS load case not including reliability factor  $\gamma_x$  of 1.5 (see EN 15129) for MSTU and 1.1 for MSTL  
 L1, LO, HP and BP dimensions include and consider reliability factor  $\gamma_x$  of 1.5 for MSTU and 1.1 for MSTL on top of  $F_d$

>> The preliminary dimensions are based on the values as follows:

- Max. inner operation pressure for ultimate load case:  
 $p = 50 \text{ MPa (500 bar) incl. } \gamma_x$
- Max. inner operation pressure for service load case:  
 $p = 25 \text{ MPa (250 bar) incl. } \gamma$
- Operating temperature range  $-40$  to  $+40 \text{ }^\circ\text{C}$
- Considered SLS load duty cycles 100,000 considering  $0.7 \times N_d$
- Damping index exponent  $a = 0.04$  for MSTL
- Lock-up velocity  $0.2 - 5 \text{ mm/s}$  to be adjusted depending on demand

>> Key characteristics of MAURER Shock Transmitters - MSTU/MSTL

- Load limiter function for  $F_d$ . Over all structural cost reduction with MSTLs in the range of 1–5 % is possible.
- High rigidity with immediate lock-up of structure within min. 1–3 mm possible depending on stroke.
- No wear and low static friction resistance in the applied triple - seal - guide system granting at least 50 years of service life without leaking.
- Suitable for extreme climate zones.
- Absolutely maintenance-free design brings reliability and safety during entire service life.
- The max. pressure is limited to 50 MPa for ultimate and 25 MPa for service load cases. This approach effectively prevents leaking.
- CE - marking is available for all devices.

# MAURER Bearing Systems for Base Isolation and Mitigation

## >> Elastomeric Isolators



Nissibi Bridge,  
Turkey

MAURER Elastomer Isolators decouple structures from their foundations during an earthquake, thereby reducing the seismic energy that impacts on the building. Elastomer Isolators are proven elastomer bearings. Depending on its formulation, the elastomer allows the seismic energy to be converted through the damage-free deformation of the elastomer molecules. The isolators transfer the vertical loads from the structure while at the same time allowing rotation and elastic Re-Centring.

### >> Classification based on mixture and structure

#### 1. Elastomeric Isolators with Low Damping

##### **MLDRB = Low Damping Rubber Bearing**

These are made up of several layers of rubber separated by vulcanized steel sheets. The isolation is attained through the shear deformation of the rubber layers. However the energy dissipation is poor, thus requiring additional measures such as the adoption of dampers to increase system damping and to decrease the structural displacements.



#### 2. Elastomeric Isolators with High Damping

##### **MHDRB = High Damping Rubber Bearing**

Their rubber compound has limited damping capability. These high-damping rubbers (HDR) have a different molecular structure. This results in equivalent damping ratios ranging from 6 % to 10 % and therefore to a slightly fatter hysteretic loop. The energy dissipation is still limited and usually requires additional damping measures for medium to severe seismic events.



#### 3. Elastomeric Isolators with Lead Core

##### **MLRB = Lead Rubber Bearing**

To increase the equivalent damping ratio up to 40 %, one or more lead cores are integrated vertically in the elastomeric isolator. When subjected to horizontal movements, the lead core offers significantly greater reaction force compared to that of Low and High Rubber Isolators. The result is a much fatter hysteretic loop with greater energy dissipation. Therefore the lead rubber bearings are the most applied elastomeric isolator type.



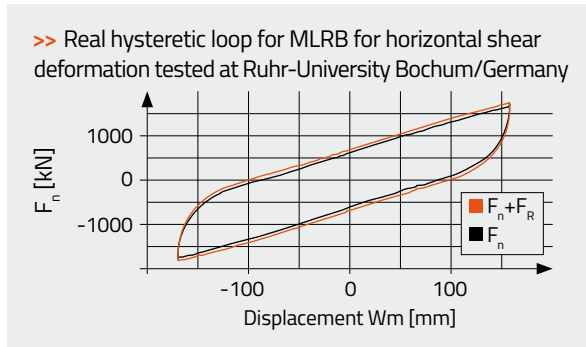
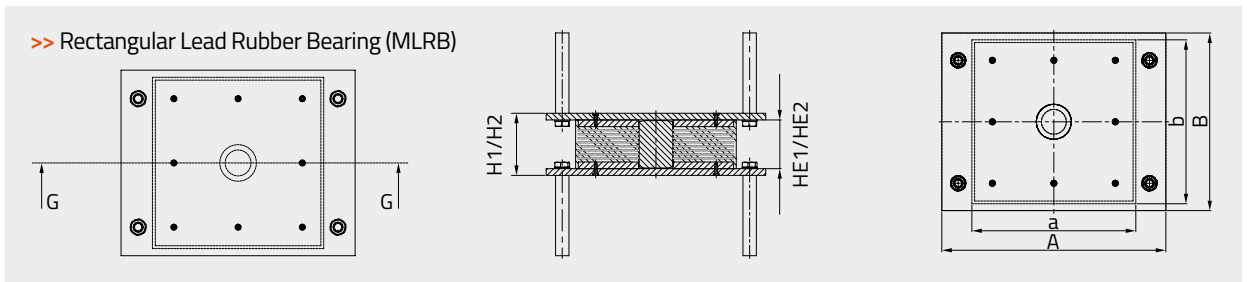

- >> Possible technical parameters:
1. Shear modulus: 0.4 to 1.35 N/mm<sup>2</sup>
  2. Equivalent Damping Ratio: ~15% to ~35%
  3. Sizes up to 1.200 x 1.200 x 550 mm, diameter 1.200 x 550 mm

>> Table of dimensions for lead core bearing (MLRB)

$N_d$	$N_{Ed,max}$	$d$	$d_{max}$	$D_r$	$D_t$	H1	a	b	A	B	H2
[kN]	[kN]	[mm]	[±mm]	[mm]	[mm]	[mm]	[mm]	[mm]	[mm]	[mm]	[mm]
1,000	700	50	200	400	600	200	400	400	600	450	210
3,000	2,100	50	200	500	700	240	500	500	700	550	270
5,000	3,500	50	200	600	800	300	600	500	800	550	300
7,000	4,900	50	200	600	800	300	600	600	800	650	310
9,000	6,300	50	200	700	900	300	600	600	800	650	310
11,000	7,700	100	300	700	900	330	700	700	900	750	340
13,000	9,100	100	300	800	1,000	360	700	700	900	750	340
15,000	10,500	100	300	800	1,000	360	700	700	900	750	340
20,000	14,000	100	300	900	1,100	360	800	700	1,000	750	340
25,000	17,500	100	300	900	1,100	360	800	800	1,000	850	370
30,000	21,000	100	300	900	1,100	390	900	900	1,100	950	370

$N_d$  = max. vertical design load combined with service displacements  $d$   
 $N_{Ed,max}$  = vertical earthquake load combined with  $d_{max}$   
 $d$  = service displacement movement load (temperature, traffic, etc.)

$d_{max}$  = total displacement for earthquake combined with service condition  
H1 = overall height of round bearing  
H2 = overall height of rectangular bearing

>> The preliminary dimensions are based on values as follows:

- Damping: 20%
- Temperature range: Service load - 25 °c to +50 °c for service load case; Earthquake load: - 13 °c to +45 °c for maximum credible seismic load case
- Shear modulus: 0.9 N/mm<sup>2</sup>
- The total displacement  $d_{max}$  already includes the recommended safety coefficients for movement as per EN 1998 ( $\gamma_x$  of 1.2 for buildings and  $\gamma_x$  of 1.5 for bridges)

>> Features and Application

- Great durability of applied various high quality MAURER synthetic chloroprene or natural rubber compounds for a life span of 20 to 40 years. Ageing effects can be better reduced by using chloroprene rubber compounds.
- Suitable for "moderate" climate zones temperatures above 0 °c. It is possible to use the elastomeric rubber isolators for - 25 °c, but the hardening effect of the rubber compound of 30–50% must be considered in the seismic design concept.
- The equivalent damping ratios are in the range of 30–35% for effective displacement limitation.
- Devices have been extensively tested and are available with CE-marking.

## >> Sliding Isolators



MAURER Sliding Isolators allow smooth horizontal displacements of the structure on a sliding surface with small base shear values. Even after ten design earthquakes, MAURER Sliding Isolators remain free of wear effects.

Therefore their lifespan matches that of the structure they are protecting. The devices are made up of a lower and upper bearing plate with a spherical MSA® sliding lens in between.

The sliding liner MSM® is an extremely stress resistant sliding material patented by MAURER and is certified in the MAURER European Technical Approval ETA-06/0131.

### >> Classification into three types

#### 1. Sliding Isolator without Re-Centring (SI)

These have a flat sliding plate that accommodates enables horizontal displacements and dissipates energy through the specified coefficient of friction between the sliding pair MSM® against stainless steel sheet.

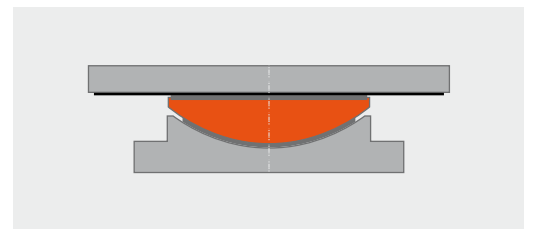

#### 2. Sliding Isolation Pendulum isolator with Re-Centring (SIP)

These have a concave sliding plate and work like a pendulum. Some of the impressed kinetic energy is converted into potential energy. This storage of potential energy provides the required recentering capability.

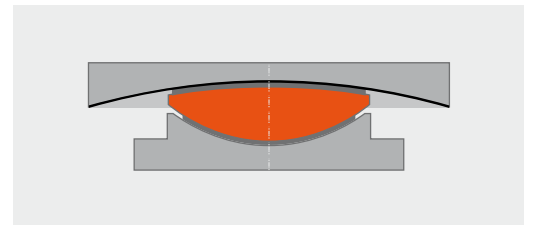

#### 3. Double Sliding Isolation Pendulum isolator with Re-Centring (SIP-D)

With these isolators, the sliding lens moves between two symmetrical, concave bearing plates, thereby doubling the displacement capacity compared to the single Sliding Isolation Pendulum isolators (SIPs) the diameter being equal. Conversely, the outer dimensions can be significantly reduced, the displacement capacity being equal.

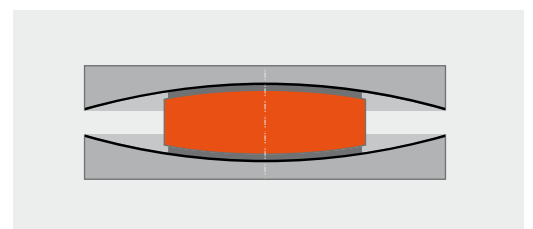

The Re-Centring force and energy dissipation for SIP and SIP-D are shown in the hysteretic loop.

Bilkent Secondary School, Turkey



>> Real characteristic hysteretic loop of a Sliding Pendulum Isolator (SIP/SIP-D) tested at University of California at San Diego/USA

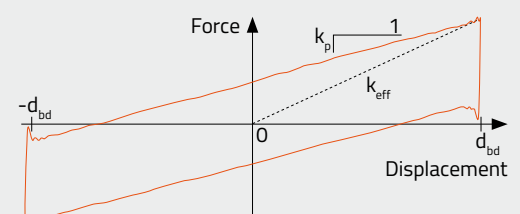

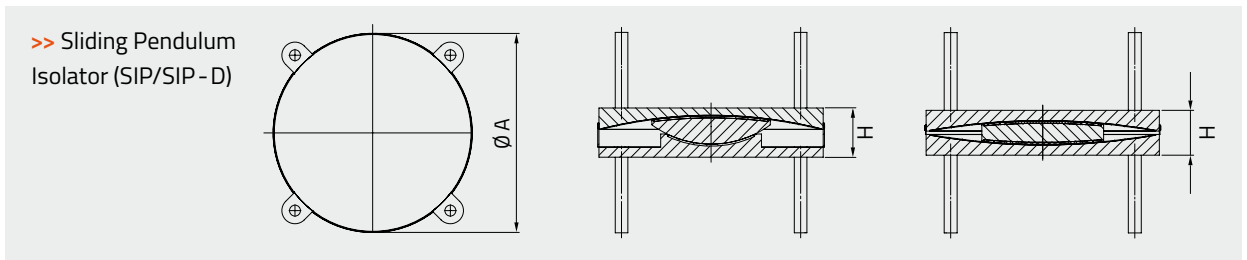

$N_{Ed} / N_{Ed,max}$ [kN]	$d_{max}$ [mm]	SIP		SIP-D	
		Plan view A* [mm]	Height H** [mm]	Plan view A* [mm]	Height H** [mm]
500 / 500	+/- 350	820	155	530	125
1,000 / 2,000	+/- 350	880	165	580	135
2,000 / 4,000	+/- 350	940	175	650	150
3,000 / 6,000	+/- 350	990	185	710	165
5,000 / 10,000	+/- 350	1,085	190	790	200
7,000 / 14,000	+/- 350	1,160	200	860	230
11,000 / 22,000	+/- 350	1,260	215	980	280
15,000 / 30,000	+/- 350	1,360	240	1,080	330
25,000 / 50,000	+/- 350	1,560	295	1,250	420
30,000 / 60,000	+/- 350	1,620	325	1,310	485
35,000 / 70,000	+/- 350	1,710	365	1,410	550

$N_{Ed}$  = vertical average seismic design load for required dynamic friction within the sliding couple  
 $N_{Ed,max}$  = max. vertical earthquake load combined with  $d_{max}$   
 $d_{max}$  = total displacement for earthquake combined with service condition (thermal/wind/creep/shrinkage)

\* based on assumption of 5 % dynamic friction for  $N_{Ed}$   
 \*\* based on assumption of 3,000 mm pendulum radius; without anchoring measures; depending on specified concrete compression stresses

>> Remarks

The dynamic coefficient of friction, the pendulum radius and the bearing movement will be adapted individually to each structure depending on the maximum allowed base shear and displacement. Bearings can be designed even for loads up to 250 MN and more.

>> Application

MAURER Sliding Isolators are applied in new buildings or bridges and for the seismic retrofitting and reinforcement of existing structures in all climate zones. They transmit extreme vertical forces, enabling huge displacements and rotations, decoupling structures from their foundations and can effectively re-centre the superstructure. Depending on the damping demand the isolators can provide this by means of friction (reasonably adapted between 1% and 7%) or even in combination with horizontally acting damping devices (see chapter of MAURER Hydraulic Dampers or MAURER Hysteretic Dampers).

>> Main features of MAURER Sliding Isolators

- The design, liner material, checking and testing provisions ruled by official state approval together with CE-marking bring reliability and safety.
- MAURER sliding isolators are absolutely maintenance-free allowing 50 – 150 years or even longer service life spans.
- Constant seismic pendulum period of the SIP and SIP-D as their period are independent of the load.
- After excessive static and dynamic testing on the MSM® liner material of up 50,000 m sliding path, the isolators exhibit no signs of ageing or wear what was tested even at the University of California at San Diego/USA! Continued functionality is granted even after ten design earthquakes, while their life span matches that of the structure itself.
- Immediate smooth displacements without stick-slip effects as static friction values are low.



## >> Hydraulic Dampers (MHD)

MAURER Hydraulic Dampers (MHD) can complement isolators and structural bearings to achieve a superior system behaviour in terms of less forces and displacements for seismic as well as service load case. They guarantee maximum damping and controlled energy dissipation. During an earthquake, an intelligent fluid flow management system permits relative movements and keeps the response force at a constant level.



### >> Functional characteristics

#### A) Service load for temperature movements (orange area):

No significant response forces greater than 2–5 % of  $F$  for velocities lesser 0.1 mm/s.

#### B) Shock load (traffic, wind, earthquake; blue area):

Sudden reaction force starting from displacement velocity ( $v_0$ ) 0.1 to 2 mm/s to block impulse actions from wind and traffic, while minimising structural movements resulting from these service load cases.

#### C) Earthquake (grey area):

The damper allows displacements and dissipates energy, while the max. response force  $F_{max}$  is maintained constantly within the specified velocity range of  $v_d$  to  $1.5 v_d$  – even including the 150 % over velocity acc. to EN 15129. As a result, the MHD, its anchoring and the structure are protected against overloading while the maximum displacements are effectively limited.

### >> Force [F]-velocity [v]-diagram of a MHD

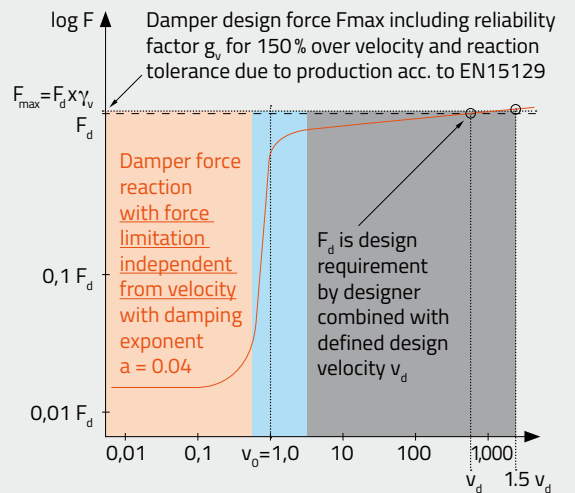

>> Real Force [F] - displacement [d] - diagram of a MHD with  $F_{max}$  of 1,900 kN and 1,300 mm total stroke capacity tested with a harmonic input at Ruhr -University Bochum/Germany

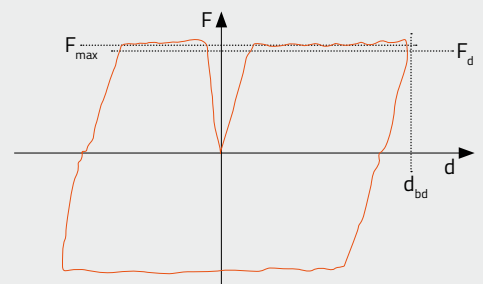

### >> Hydraulic Damper (MHD)

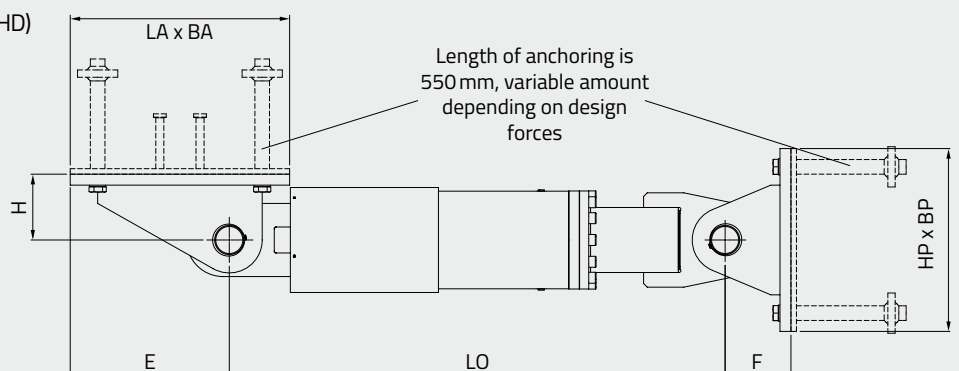

$F_0$	$d_1$	$LO_1$	$d_2$	$LO_2$	$d_3$	$LO_3$	E	F	H	LA	BA	HP	BP
[kN]	[±mm]	[mm]	[±mm]	[mm]	[±mm]	[mm]	[mm]	[mm]	[mm]	[mm]	[mm]	[mm]	[mm]
500	100	1,140	300	2,110	600	3,610	350	140	220	500	350	400	350
1,000	100	1,270	300	2,180	600	3,720	455	160	240	650	400	450	380
1,500	100	1,420	300	2,300	600	3,830	490	190	260	700	450	500	410
2,000	100	1,530	300	2,420	600	3,930	525	200	280	750	500	550	450
2,500	100	1,680	300	2,550	600	4,090	560	220	300	800	550	600	490
3,000	100	1,790	300	2,670	600	4,210	595	230	350	850	600	650	550
3,500	100	1,960	300	2,820	600	4,370	630	250	350	900	650	700	600
4,000	100	2,100	300	2,990	600	4,500	700	270	380	1,000	700	750	630
4,500	100	2,240	300	3,110	600	4,650	770	290	380	1,100	750	800	660
5,000	100	2,380	300	3,260	600	4,770	840	300	380	1,200	800	850	700
5,500	100	2,510	300	3,420	600	4,910	910	320	390	1,300	850	900	750
6,000	100	2,660	300	3,520	600	5,050	980	330	390	1,400	900	950	800
6,500	100	2,790	300	3,640	600	5,160	1,050	340	400	1,500	950	1,000	830
7,000	100	2,940	300	3,840	600	5,350	1,120	350	400	1,600	1,000	1,050	860
7,500	100	3,070	300	3,940	600	5,490	1,190	360	420	1,700	1,050	1,100	900
8,000	100	3,230	300	4,100	600	5,670	1,260	380	430	1,800	1,100	1,150	950

$F_0$  = design force value for the ULS load case without reliability factor  $\gamma_v$  of 150 % on velocity  
 $d_1, d_2, d_3$  = various displacement assumptions with correlating dampers dimensions

>> The preliminary dimensions are based on values as follows:

- Max. velocity  $v = 300$  mm/s => can be adopted on demand even for 1,500 mm/s or greater
- $F_{max}$  is not significantly greater than  $F_0$
- Max. internal working pressure for ultimate load case  $F_{max}$ :  $p = 50$  MPa (500 bar)
- Frequently occurring service forces due to traffic, wind, etc.:  $F_{service} = 0.5 \times F_{max}$   
 200,000 load cycles considered  $F_{service}$  with max. 25 MPa inner pressure
- Damping index exponent  $a = 0.04$  => can be adopted on demand even up to linear viscous behaviour  
 ( $a = 1$ ) and/or even hybrid damping exponent functions can be achieved
- Temperature range from  $-40$  to  $+40$  °c
- Over velocity and manufacturing tolerances are considered acc. EN 15129 for  $F_{max}$  within the reliability factor  $\gamma_v = (1+t_d) \times (1.5)^a$  which is multiplied with designer's force specification  $F_0$

>> Key characteristics of MAURER Hydraulic Dampers

- No leaking effects due to the triple-seal-guide system avoiding wearing or fatigue.
- Protection of device and structure by effective force limiter function with a special valve system:  $F_{max}$  is not much bigger than  $F_d$ , as  $\gamma_v$  will be in the range of 1.07 to 1.12 only, including production tolerances (td) of 0.05 – 0.10 .
- Less displacements and forces within the system with damping indices exponents of 0.04 to 1.0 . Hybrid systems consisting of various exponents for the correlating velocity ranges are possible.
- Immediate lock-up after min. 1–3 mm displacement for service forces resulting from high rigidity due to low compressibility (only 0.5 to 3 %) of the hydraulic oil.
- Optimum performance in any climate zone. Functional characteristics virtually independent of the temperature within  $-40$  to  $+40$  °c.
- Optimized design with CE-marking which is absolutely completely maintenance-free.
- No long term leaking in its resting state as the MHD is not pre-stressed and is not under any significant pressure.
- MAURER can provide semi-active dampers especially adapted to the needs of stay cables and tuned mass dampers.

## MAURER Steel Hysteretic Dampers (MSHD)

Plastic deformation of steel is one of the most effective mechanisms available for the dissipation of energy, from both economic and technical point of view. The idea of utilizing Steel Hysteretic Dampers (SHDs) within a structure to absorb large portions of seismic energy began with the conceptual and experimental work in the 1970s.

Steel dissipaters for SHDs have been conceived and manufactured in a very large geometric configuration variety. Their strong points are: (i) good reliability, (ii) constant performance independent from temperature and impressed

velocity, (iii) high resistance to ageing, (iv) no need for maintenance and (v) limited cost. Nonetheless, their most serious drawback is the limited capacity of accommodating large displacements, as required in structures erected in areas of high seismicity, particularly bridge structures. In response to this concern, MAURER has developed and experimentally investigated two types of SHDs, in which energy dissipation is achieved by subjecting the hysteretic elements to two distinct impressed movements, namely axially and in torsion respectively.

### >> A) Compact Steel Damper (MCS D) operating in one direction (tension & compression) with moderate Re-Centring capability

Buckling-Restrained Braces (BRBs) have already been used as diagonal braces in buildings and also in long-span bridges. In the latter case, the foremost BRBs' drawback resides in their excessive length, which severely limits their applicability to those cases where large spaces are available for their installation. The patented MCS D device solves this problem by reducing by a factor of 3 the axial overall dimension. Thus, according to Euler's theory, the buckling load increases by a factor of 9 compared with an existing BRB, the reaction force and displacement capacity being equal.

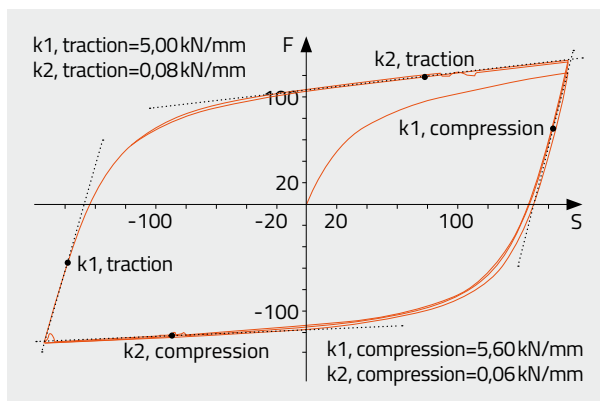

### >> Key characteristics of MCS D

- very compact design
- good reliability
- elastic displacement capacity up to  $\pm 50$  mm
- large plastic displacement capacity  $\pm 300$  mm
- very long service life up to 100 years
- high resistance to ageing and absence of wearing
- capable of providing the "fifth function" to isolation systems (high initial stiffness under service loads)
- no need for any maintenance
- resistance to at least three design level earthquakes
- cost effective

>> For MCS Ds geometrical characteristic please refer to the table of page 15 relevant to Hydraulic Dampers



### >> Section A-A

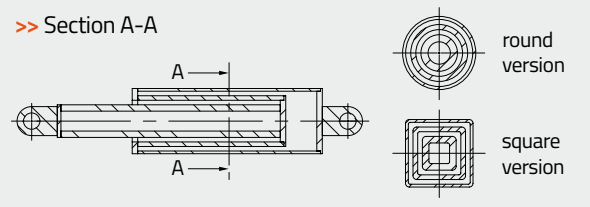

### >> B) Re-Centring Steel Damper (MRSD) horizontally operating in two directions and providing excellent Re-Centring

The particular feature of this damper is that it is the only one of its kind that can generate sufficient elastic forces, resulting in excellent structural Re-Centring properties combined with highest possible damping efficiency and lowest possible base shear values. The MRSD works equally in any horizontal direction. It can be used applied within structures for great forces (2,000 kN and more) with big high displacements of up to  $\pm 1,5$  m. In view of the changing rigidity as a function of

the displacement amplitude and powerful force increase at the end of the movement displacement capacity, the structural displacements are reduced by up to 30% compared to conventional hysteretic dampers, hydraulic dampers or single/multiple sliding pendulum isolators. The dampers are therefore ideal as for structural Re-Centring dissipaters in addition to seismic isolators within buildings and bridges. They can also be inserted into diagonal struts of any steel structures.

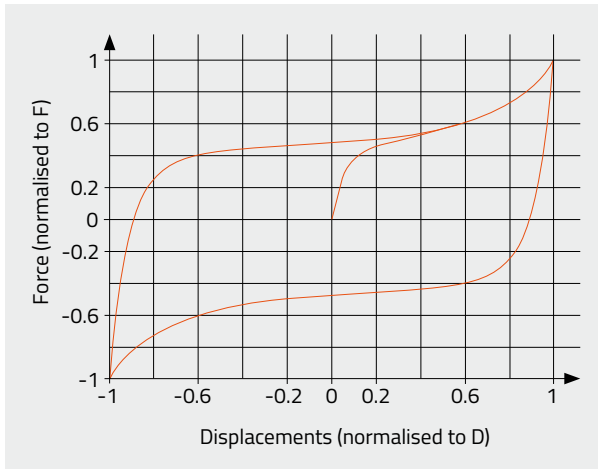

>> **C) Adaptive Re-Centring Torsion Isolator (MARTI) operating in two horizontal directions and providing good Re-Centring**  
 The MARTI is an isolator and a damper in a perfect symbiotic combination. The isolator part of the device will provide vertical load transmission, lateral flexibility and a small amount of damping by friction, complemented by the hysteretic damper part through further damping and Re-Centring. The damper part is identical to the MRSD, which is a device for its own and the MARTI is a combined device.

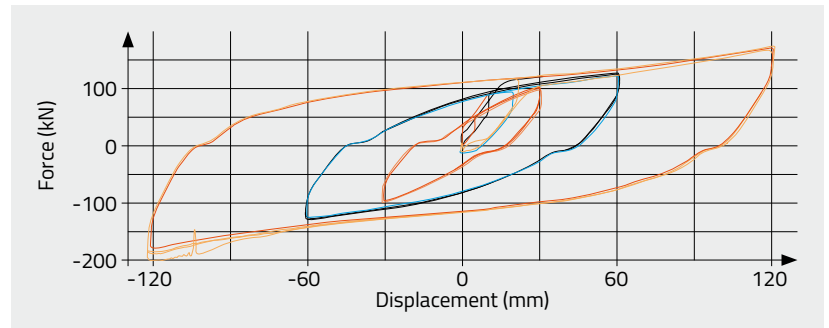
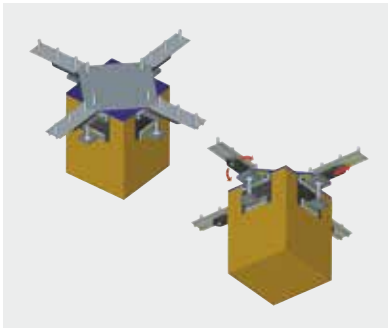

### >> Key characteristics of MARTI and MRSD

- The initial static friction is very low ( $\mu_{stat} = 1-5\%$ ), what prevents any start impact when the first seismic displacement occurs.
- Grants with more than 40% damping lowest possible base shear values down to 0.06 of structural dead load with still perfect Re-Centring of the structure.
- Great reliability as damping performance is not excessively influenced by load, temperature and velocity.
- 100% reliability for continued functionality under the considered MCE event. The hysteretic elements survive at least three MCE events. No ageing or contamination problems.

## MAURER Earthquake Expansion Joints for Road Bridges

>> **Expansion Joints with reserves for extreme situations. In order to ensure that threshold loads do not get transferred into the bridge structure.**

Expansion Joints in road bridges are used to compensate movements between the adjacent structures while at the same time transferring traffic loads. They must be designed in accordance with the structural bearings degree of freedom and must be able to permanently withstand the effects in their service state. Key influencing parameters for movement in the service state include temperature fluctuations, creep/shrinkage of the concrete and imposed loads such as wind and braking. Earthquake effects generate additional, in some cases significant deflections and displacements that vary considerably in terms of their size, direction and velocity from the service state.

### >> Particular requirements for Expansion Joints in earthquake areas

- Kinematic behaviour of the expansion joint in a longitudinal and lateral direction
- Possible maintenance of emergency services following the earthquake
- Consideration of the difference in incline between the road and its bearings
- Reasonable volume of damage after an earthquake
- Influence of velocity (up to 1.5 m/s) and acceleration
- Traffic safety during the earthquake
- Proof of expansion joint kinematics in tests. Clear distance required between structural parts, e.g. as per EN 1998-2







>> MAURER offers the following types of construction that are particularly suitable for use in earthquake regions:

Construction type	Features
Girder Grid Joint Type DT 160/240 ★☆☆☆☆	suitable for combined movements of 240 mm longitudinally and 60 mm laterally to the structure
Swivel - Joist Expansion Joints of Type DS ★☆☆☆☆	unlimited suitability, even for combined movements longitudinally and laterally to the structure
Girder Grid Expansion Joint of Type DT 160/240 with Fuse Centre Beam (MFC) ★☆☆☆☆	pre-determined breaking device, suitable for large movements from earthquakes and small movements in service state; suitable for combined movements in a longitudinal direction and max. 60 mm laterally to the structure
Fuse Edge Beam (MFE) ★★☆☆☆	pre-determined breaking device suitable for movements of up to 240 mm in service state and reduced earthquake closing movement
Fuse Box Ramp (MFBR) ★★★☆☆	pre-determined breaking device suitable for reducing the number of lamellas in the event of major earthquakes for connection to concrete
Fuse Box Shear (MFBS) ★★★★☆	pre-determined breaking device suitable for reducing the number of lamellas in the event of major earthquakes for connection to steel
Fuse Box Lateral (MFBL) ★★★★☆	pre-determined breaking device suitable for absorbing excessiv lateral movements

★ Degree of Seismic Protection level

## MAURER Swivel-Joist Expansion Joints of Type DS

MAURER Swivel-Joist Expansion Joints of Type DS are the flagship of modular joints. By controlling each individual lamella separately, service movements can be absorbed virtually limitlessly in the longitudinal direction, as well as lateral bridge

movements of +/- 1.5 m lateral to this. Depending on the sealing profile these movements can be 80 mm or +/- 40 mm (ETAG 032). The individual dimensions of the standard constructions can be found in the MAURER Swivel-Joist brochure.



Russkiy Island Bridge, Vladivostok, Russia

There are numerous references to illustrate the use of MAURER Swivel-Joists in earthquake zones, including the Vasco da Gama Bridge in Lisbon, the Rion Antirion Bridge in Greece, the Bolu Mountain Highway in Turkey or the Russkiy Bridge in Vladivostok.



Harilaos Trikoupi Bridge, Greece

>> Capability of accomodating all types of impressed deformations

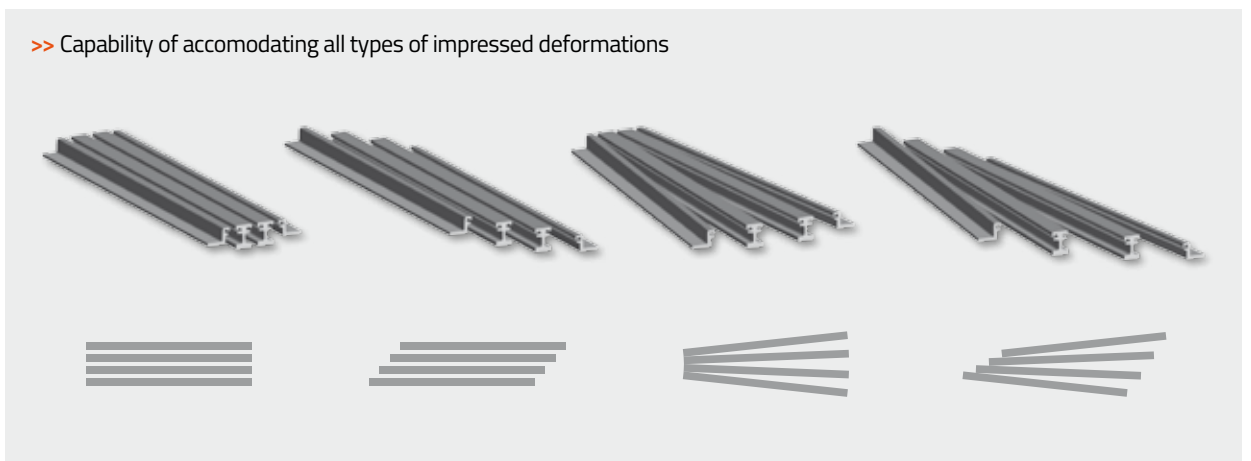

## MAURER Fuse Box for Modular Joints

>> **The MAURER Fuse Box: Functional security in extreme situations.**

MAURER Fuse Box Systems permit constructive yielding of the bridge closing movements up to the anticipated threshold state (ULS) and possibly even beyond it. Depending on the Fuse Box System, the resulting closing movement is absorbed: either through an oblique-angled, upwards-deflecting plane of movement or through a vertical lowering of the construction with subsequent sliding in the joist box. For excessive lateral movements, the lateral fuse system permits the absorption of unlimited magnitudes of movement regardless of the geometric design of the bridge's cross-section. The Fuse Box System protects the deck of the bridge from excessive loads and destruction. After the quake, the bridge's isolation system becomes active as a returning tool. The activated Fuse Box can ensure the safety for crossing of rescue services. Fast and simple repair of the construction and its road surface is now possible.



University of Berkeley/California, Seismic testing site



>> **The three key advantages of a MAURER Fuse Box**

→ Protection of the bridge deck during the earthquake against horizontal over-stressing caused by closing movements.

→ Avoidance of open structural gaps caused by excessive opening movements

→ Bridge structure can be driven over by emergency and support vehicles after the earthquake.



MAURER systems withstand not only every earthquake, but also the world's toughest certification processes.

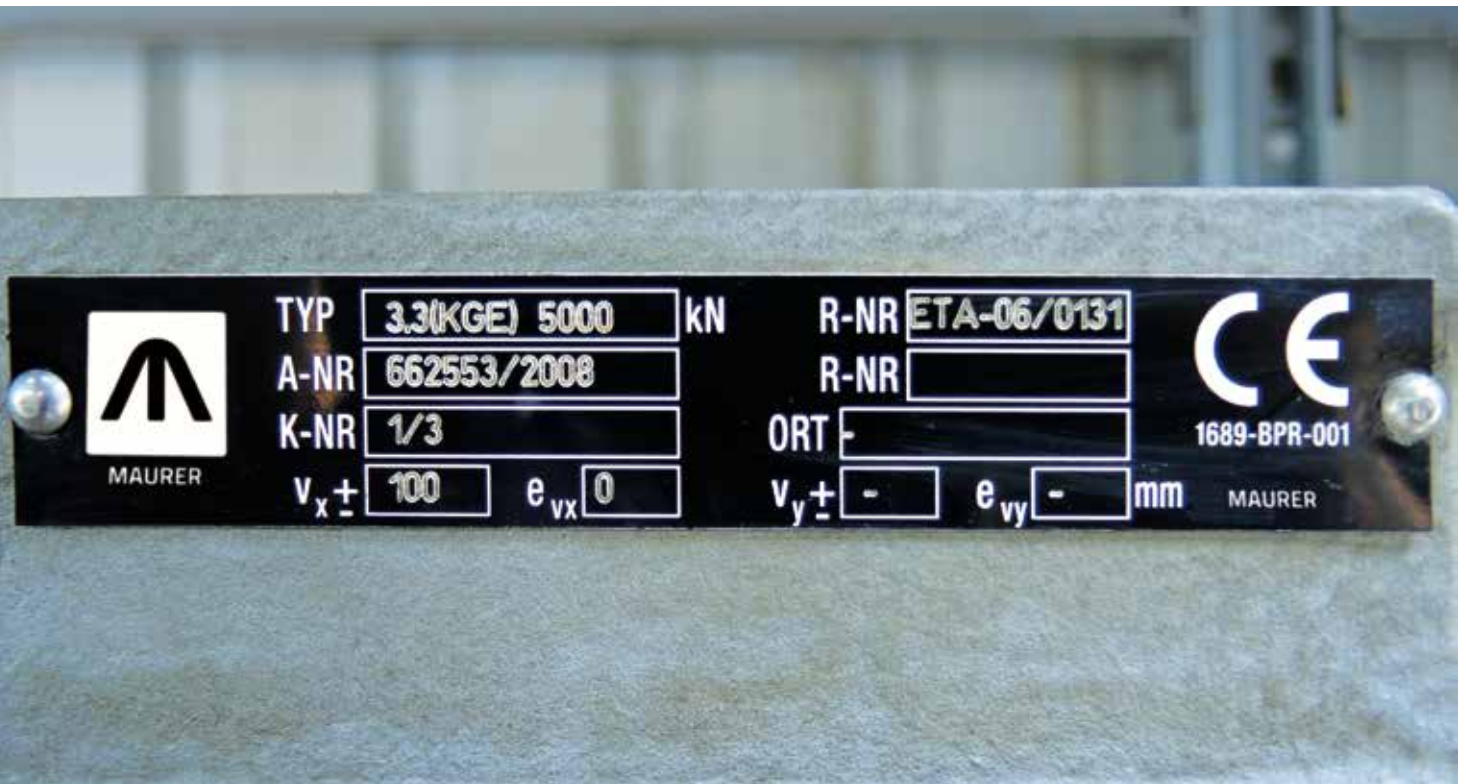

The components for earthquake protection are measured and tested according to EN 1337, EN 15129, AASHTO or any other preferred standards on an individual, project-related basis.

The European standards ensure the CE mark and certify conformity. Third-party monitoring is required, e.g. by the Materials Testing Institute (MPA) of the University of Stuttgart or other certified, independent institutions.

The tests of the earthquake devices have already been carried out at the University of the Federal Armed Forces in Munich / Germany, the Ruhr - University in Bochum / Germany, the EU Centre at the University of Pavia / Italy and the ISMES Institute in Bergamo / Italy, the Politecnico di Milano / Italy, the University of California in San Diego / USA and the University of California in Berkeley / USA.

>> MAURER type plate

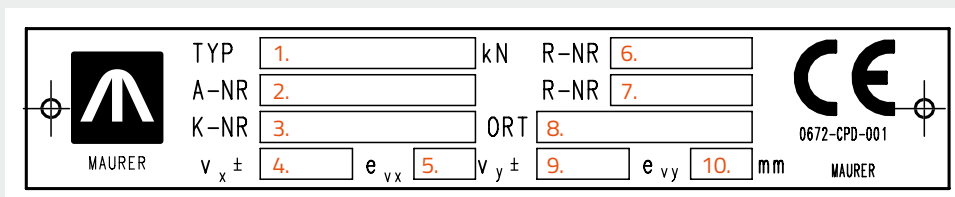

- |                        |                            |                            |
|------------------------|----------------------------|----------------------------|
| 1. Storage type        | 4. Displacement            | 7. Set of Rules Standard 2 |
| 2. Job number and year | 5. Presetting              | 8. Installation location   |
| 3. Page number         | 6. Set of Rules Standard 1 | 9. + 10. Presetting        |

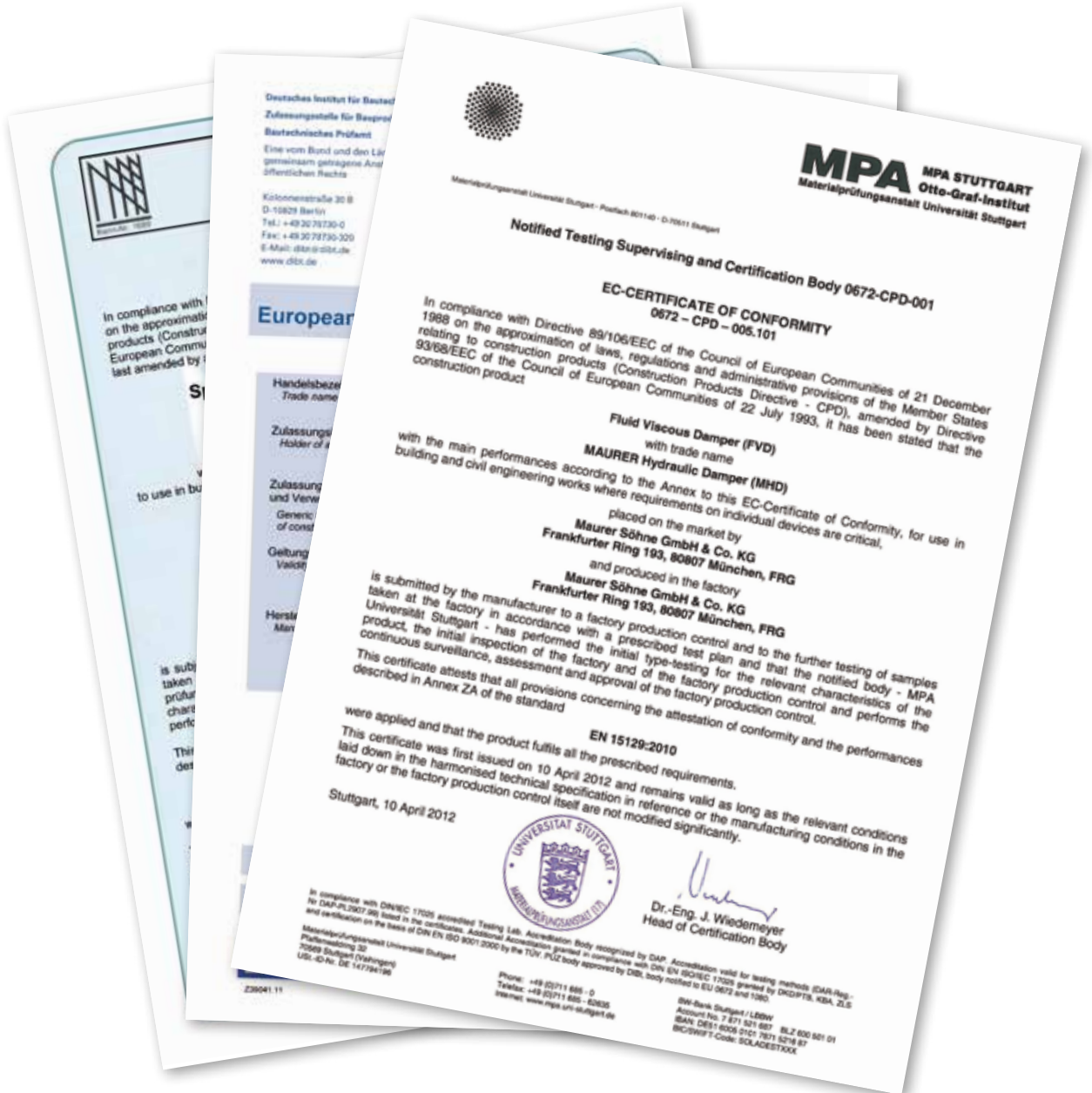

>> Excerpt from certificates and European Technical Approvals for:

- MAURER MSM® Spherical and Cylindrical Bearings .....European Technical Approval ETA-06/0131 DIBT
- MAURER MSM® Spherical and Cylindrical Bearings .....EC Certificate of Conformity MPA Stuttgart 0682-CPD-005.2
- MAURER Elastomer Bearings .....EC Certificate of Conformity MPA Stuttgart 0672-CPD-005.5
- MAURER Sliding Pendulum Bearings Type SIP .....EC Certificate of Conformity MPA Stuttgart 0672-CPD-005.102
- MAURER Hydraulic Dampers (MHD) .....EC Certificate of Conformity MPA Stuttgart 0672-CPD-005.101
- MAURER Lead Core Bearings (MLRB) .....Certificate of Constancy of Performance 0672-CPR-0362



## Individually adapted testing of seismic devices

On request MAURER will do static and dynamic testing on any seismic device according to the required standards. It is important to test not only for ultimate seismic load cases but also, if relevant, for the structure, consider frequently occurring service load cases (wind, braking of railway, traffic loading vibrations, etc.).

The seismic testing is finally confirming the capability of energy dissipation with its upper and lower bounds, the stiffness, the stability and integrity of the device, and the durability that even after more than five design earthquakes MAURER devices do not suffer of any damages.

The aim of testing for service load condition is more related to the proof of wear resistance (10,000 m sliding test for thermal or traffic displacements), fatigue resistance (up to several million load cycles of wind loading), initial high stiffness resistance to lock-up for service impact loadings (railway, wind, etc.) and general durability.

### >> Atomic Power Plants and Wind Parks/Europe

Tests at University of Armed Forces Munich/Germany of structural rubber isolators for 900 kN to 6,590 kN service load capacity, lateral up to +/- 120 mm and 2 mm to 15 mm vertical displacement with 0,04 Hz to 1 Hz.



### >> Incheon Airport Project/Korea

Test at EU Center University Pavia/Italy of SIP pendulum isolator for 35,000 kN load capacity, +/- 200 mm displacement and 0.175 Hz for seismic application in an access bridge.

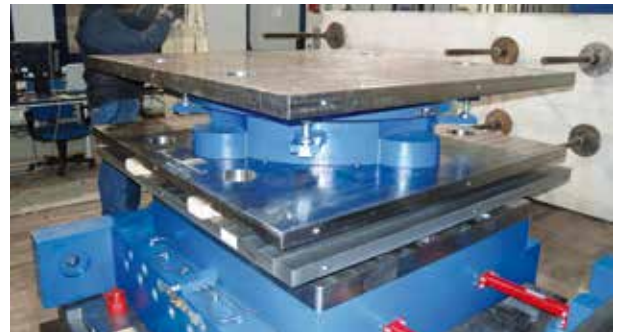

### >> Russkiy Bridge Project

Test at CALTRANS University of California San Diego/USA of MHD damper for 3,000 kN service and up to 5,000 kN ultimate force, 800 mm stroke, - 40 °c and up to 750 mm/s as the application is for service wind and ultimate seismic load conditions with low temperature requirement.



### >> Axios Railway Bridge Project/Greece

Test at Ruhr-University Bochum/Germany of MLRB lead rubber bearing for 22,000 kN load capacity, +/- 260 mm displacement and 250 mm lead core diameter inside for great energy dissipation capacity during seismic load conditions.



## No two structures are the same – nor any MAURER system.

### >> Russkiy Bridge in Vladivostok / Russia

**Task:** Structural protection against wind and earthquakes on what is currently the widest spanning cable-stayed bridge in the world with a pylon distance of 1,104 m.

**Scope of the project:** Swivel - Joist Expansion Joints of 2.4 m movement and slip security (XLS 2400), MAURER MSM® spherical (KGA; KGE) and horizontal force bearings with 34 MN superimposed load, plus 25 MN horizontal force, hydraulic wind/earthquake dampers (MHD) for 3 MN and 2.2 m of movement, passive and adaptive cable-stayed dampers for up to 578 m long cables.



### >> New Acropolis Museum in Athens /Greece

**Task:** Structural isolation to protect against earthquakes for a 33,000 tonne new building.

**Scope of the project:** MAURER MSM® Sliding Pendulum Bearings with an upper Sliding Plate (SIP - S) for up to 13.6 MN of superimposed load and +/- 255 mm of movement.

### >> Las Piedras railway viaduct to the north of Malaga /Spain

**Task:** The Spanish high - speed train AVE generates very high braking forces in the 1,200 - metre long viaduct, but these must not be allowed to cause any significant structural movements. In addition, the up to 93 - metre tall and flexible pillars are subjected to considerable stress during earthquakes of 0.1 g.

**Scope of the project:** MAURER MSM® Spherical Sliding Bearings (KGA, KGE KF) for up to 25 MN of superimposed load, 2 MN of horizontal force and +/- 350 mm of movement. Hydraulic Dampers (MHD) for 2.5 MN, plus +/- 350 mm of movement with shock transmitters and load limiter function (MSTL) for brake loads.



>> Djamaâ El Djazir Mosque in Algiers /Algeria

**Task:** The maximum earthquake acceleration on the 145-metre long, 145-metre wide and 65-metre tall main building is around 0.65 g due to the safety constructions and weight of the structure. Even at this acceleration, the structure and its contents must not sustain any significant damage.

**Scope of the project:** MAURER MSM® Sliding Pendulum bearings with two Sliding Plates and Rotational Joint (SIP-DR) for up to 27 MN and +/- 655 mm of movement; Hydraulic Dampers (MHD) for 2.5 MN, plus +/- 655 mm of movement.



>> Nissibi Bridge / Turkey

**Task:** The 610-metre long bridge is to be placed on elastic/floating bearings for service and earthquake states. The temperature fluctuations must also be distributed evenly across the structure and the maximum movement amplitudes limited in the event of an earthquake.

**Scope of the project:** MAURER Lead Core Elastomer Bearings (MLRB) for up to 31 MN of superimposed load and +/- 380 mm of movement.

>> SOCAR Tower in Baku /Azerbaijan

**Task:** The headquarters of the State Oil Company of Azerbaijan (OSCAR) is 200 m tall and symbolises the shape of a flame. As a result of its elastic, flexible construction, significant structural accelerations can occur on the upper storeys in certain wind loads and in the event of earthquakes that cause discomfort for the building's inhabitants.

**Scope of the project:** MAURER Mass Pendulum Damper (MTMD - P) with a 450-tonne pendulum mass including Hydraulic Damper (MHD) for the damping of 0.16–0.32 Hz in the X and Y direction and +/- 400 mm of movement in all horizontal directions. As the end stops, four Lead Core Bearings (MLRB) were provided for the 450-tonne mass block; a monitoring system for movement and acceleration was included.







>> Franjo Tujman Bridge near Dubrovnik/Croatia

**Task:** The 518-metre-long stayed-cable bridge lies in an earthquake zone of moderate intensity. As a result, the flat sliding bearings need to be designed for larger movements in a lateral direction and be designed to transfer lifting forces. The bridge deck movements in a longitudinal direction are reduced through hydraulic dampers to +/- 150 mm in an earthquake load situation. The abutments are fitted with Swivel - Joist Expansion Joints that can absorb the required horizontal and vertical movements.

**Scope of the project:** MAURER Traction - Compression Pot Bearings (TGA-Z) with a load capacity of 975 t; Hydraulic Dampers (MHD) with 2,000 kN and 500 mm of total movement; Swivel - Joist Expansion Joint DS 560 F; 40 - 150 kN cable - stayed dampers.

>> Harilaos Trikoupi Bridge near Patras/Greece

**Task:** The 2,250-metre long bridge deck needs to compensate enormous movement amplitudes from temperature fluctuations and earthquakes at the abutments. The foreshore ramps need to be supported with elastic floating bearings.

**Scope of the project:** MAURER Swivel - Joist Expansion Joints DS 2480 F; Elastomer Bearings with a 3,100 kN load capacity.



>> Donau City Tower in Vienna/Austria

**Task:** The 220-metre tall building vibrates in high winds and earthquakes. The accelerations for a wide range of loads and frequency fluctuations are to be reduced to provide adequate comfort. To do this, a 300-tonne pendulum mass is used in a mass pendulum damper.

**Scope of the project:** MAURER Semi-Active Hydraulic Dampers (MRD) for 30 - 80 kN and +/- 700 mm of movement to dampen the 300-tonne-mass pendulum; monitoring system for movement, force and acceleration included.

**MAURER SE**

Frankfurter Ring 193  
80807 Munich

PO Box 440145  
80750 Munich

Phone +49.89.323 94-0  
Fax +49.89.323 94-338

[info@maurer.eu](mailto:info@maurer.eu)  
[www.maurer.eu](http://www.maurer.eu)

---

German Engineering since 1876

